

D C B A

4

3

2

1

4

3

2

1

0.290 DIA THRU, EXTRUDE
0.310 DIA X 0.020 HIGH FS
INSTALL PEM F-832-2 NS
(4X). SPECIAL ANVIL REQ'D
FOR HARDWARE INSTALLATION

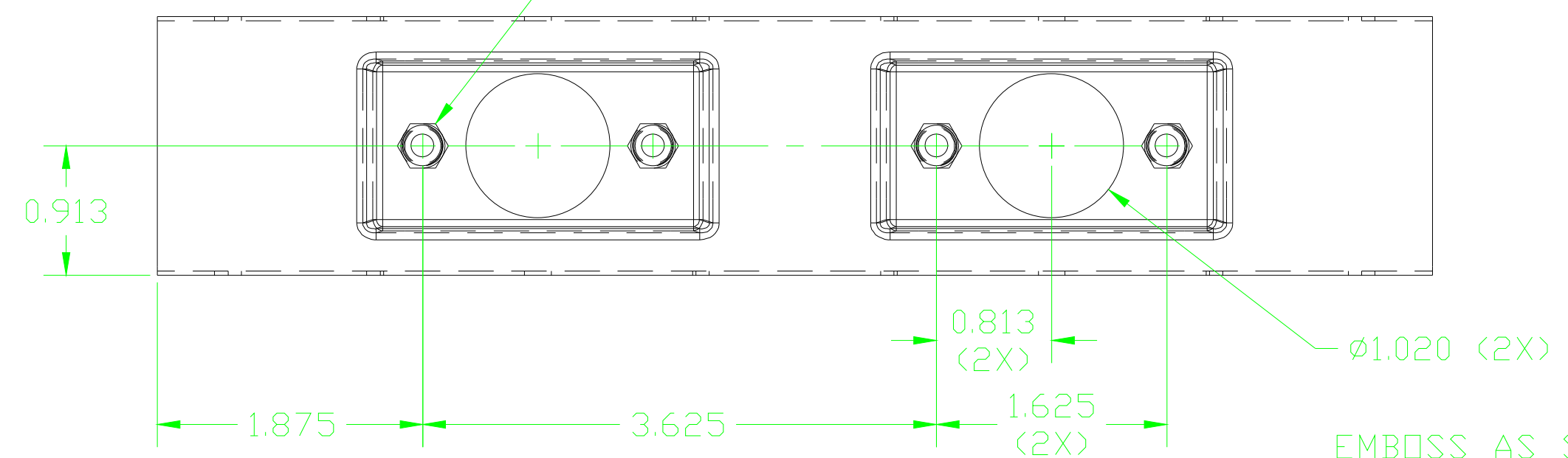

EMBOSS AS SHOWN
EMBOSS TOOL

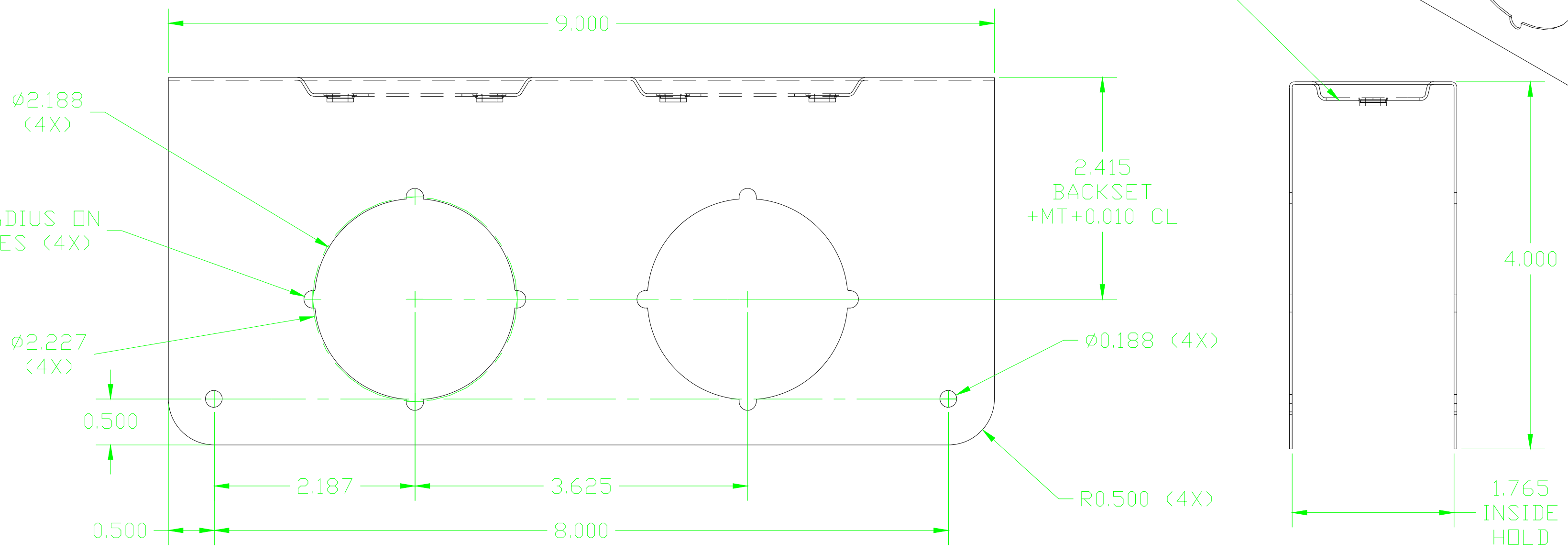
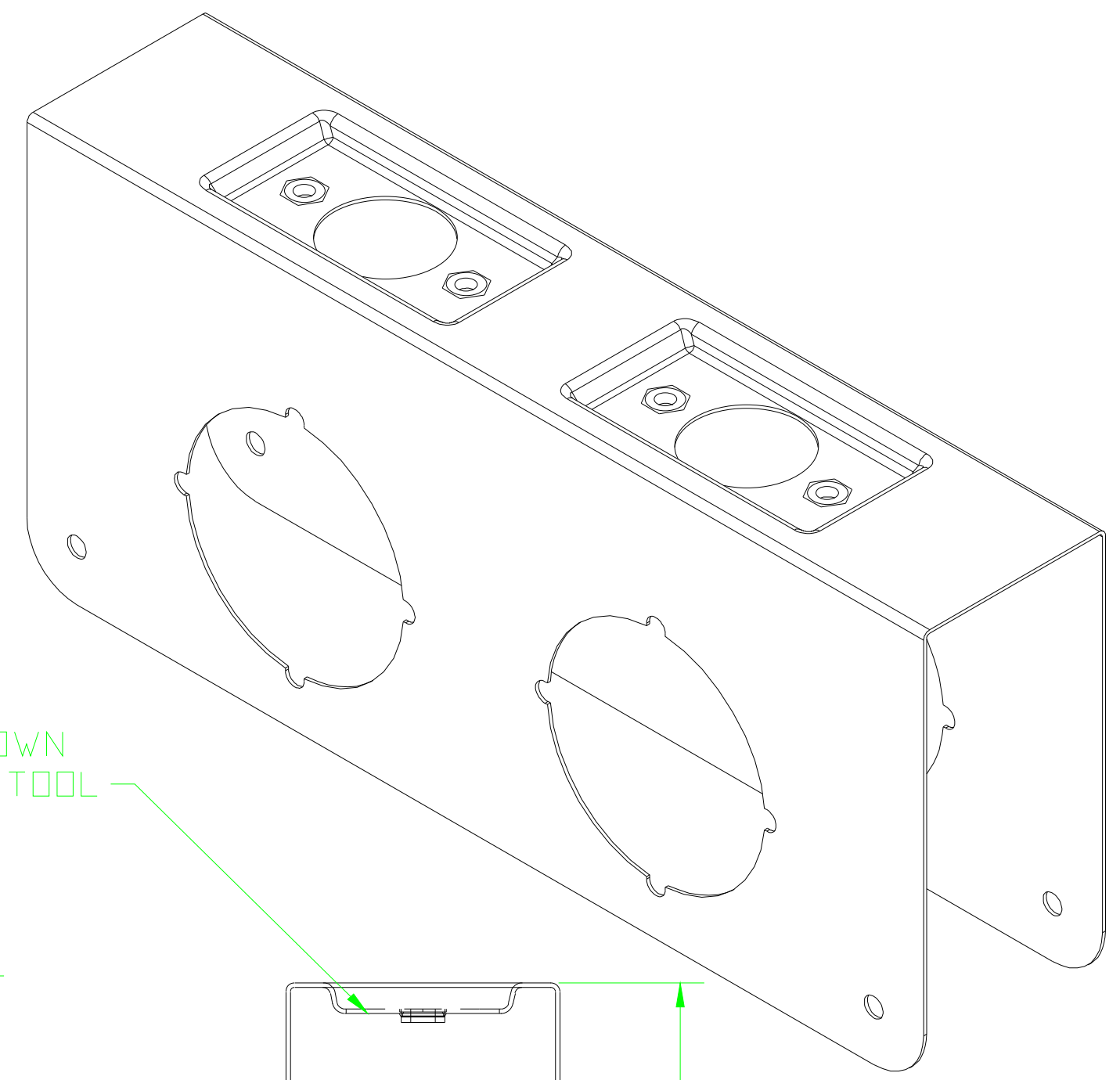

PRO-LOK[®]

655 North Hariton Street • Orange, CA • 92868
714.633.0681 / PRO-LOK.COM



Item: **EWP-221**

D C B A